

Model 420 and Model 425 Flame Photometer

Operator Manual

Sherwood Scientific Limited
1 The Paddocks
Cherry Hinton Road
Cambridge
CB1 8DH
United Kingdom

Copyright © Sherwood Scientific Limited 2017

Short Form Instructions Model 420/425 Flame Photometer

The Default mode for the Model 420/425 that will appear when the instrument is switched on is: -

Dual channel Sodium and Potassium with Peak detection and Reference mode selected. These instructions are to be used in the default mode.

NB *In Reference Mode the Blank solution, as well as the Calibration Standard and Sample, must contain 100ppm Li (Use the Blank solution to dilute the Standards and Samples).*

Operation: -

Set Up and Ignition

1. Ensure that the 'U' tube is full of deionised water.
2. Connect the gas supply (maximum 30psi Propane or Butane) via a Primary regulator.
3. Switch on the compressor and regulate the air pressure to 11psi on the gauge at the rear of the instrument.
4. Switch on the instrument with the "1/0" switch.
5. If the flame ignites then an auto sequence will test various circuits and end with the '000' flashing in both channel displays.
6. If the flame does not ignite, switch off, wait 15 to 20 seconds and repeat step 4. It may take 3 or 4 attempts if the instrument has not been used for some time.

Blanking (Zeroing)

7. With the '000' flashing aspirate the blank solution and press the 'Blank' button once.
8. The instrument will then zero to the blank values; this will take at least 30 seconds; Remove the blank when complete.

Calibration

9. When the blanking procedure is complete, the previous calibration values that were used will appear in the displays and the 'Cal' indicators will flash. If you wish to calibrate to these values go to 11.
10. If you wish to change the values use the '+' and '-' keys before aspirating the standard solution.
11. Then press the Sodium 'Set' button, then start aspirating the standard and press the Potassium 'Set' button within a few seconds.
12. Once the instrument has calibrated itself then the 'Cal' lights will flash; remove the standard and press 'Set' on both channels again.

Measuring a Sample

13. After 5 seconds both displays will flash and the "Measure" light will illuminate, the first sample can now be measured.
14. Aspirate the sample and then immediately press the 'Print/Measure' button.
15. The instrument will measure the sample until the peak algorithm captures the value and the measure light shows continuously. Remove the sample.
16. After 5 seconds the displays will flash and the next measurement can be made.

Table of Contents

	Page
Short Form Instructions Model 420/425 Flame Photometer	2
Operation: -	2
1 INTRODUCTION	6
1.1 Contacting Sherwood Scientific	6
1.2 Using this manual	6
1.3 Safety Precautions	7
1.4 Reagents	8
Reference/Lithium Standard	8
Blank Storage	8
Purification	8
1.5 Dilutions	8
Dilution Ratio	10
Urine Samples	10
1.6 BlueNotes	17
1.61 BlueNotes Software Installation	13
1.7 Warranty	17
2 INSTALLATION	18
2.1 Location	18
2.2 Services Required	18
Electrical Supply	18
Fuel	18
Air	18
Waste Container	18
2.3 Unpacking	19
Accessory List	19
2.4 Assembly	20
2.5 Connecting Peripheral Devices	24
Printer	24
Computer	24
Analogue Devices	24
Auto-sampler	24
2.6 Setting Date and Time	25
2.7 Setting Filter Factors	26
2.8 Setting Units	26
2.9 Setting Sample Delay (in Peak mode)	27
2.10 Setting the Output Voltage	27
2.11 Setting the analogue damping coefficient	27
3 PRINCIPLES OF OPERATION	28
3.1 Application of Flame Photometry	28
3.2 Principles of Flame Photometry	28
3.3 The Internal Standard Mode	29
4 PERFORMANCE CHARACTERISTICS & SPECIFICATIONS	30
4.1 Readout	30
4.2 Measurement Ranges	30
4.3 Specificity	31
4.4 Accuracy	31
Linearity	31
Drift	31
Reproducibility (using Peak mode)	31
Using Peak with Ref (Internal Standard) Mode	31
4.5 Warm Up	32

4.6	Sample Requirements	32
	Type	32
	Method of Presentation	32
	Volume.....	32
4.7	Chart Recorder Output.....	33
4.8	Environmental Conditions.....	33
	Temperature	33
	Humidity	33
4.9	Power Requirements	33
	Voltage.....	33
	Power	33
4.10	Fuel	33
4.11	Air.....	34
4.12	Size	34
4.13	Weight	34
5	DESCRIPTION OF INSTRUMENT.....	35
5.1	Front Panel Controls and Indicators.....	35
5.1.1	Controls.....	35
	‘-’ ‘Set’ ‘+’	35
	Blank	36
	Single/Dual and Element Selection	36
	Peak/Ref/Cont	36
	Measure	37
5.1.2	Description of Indicators.....	37
	Cal (Ch1 & Ch2).....	37
	Single	37
	Dual.....	37
	Peak.....	37
	Ref.....	37
	Cont.....	38
	Measure	38
	Flame On	38
	Power On	38
5.2	Rear Panel Controls and Connections	38
	Channel 1 & 2 Data Outputs.....	39
	RS232/Printer Output	39
	External Device Output	39
	Power	39
	Gas.....	39
	Air.....	39
	Air Regulator.....	39
5.3	Operating Modes	40
5.3.1	Single/Dual Mode.....	40
	Single	40
	Dual.....	40
	Blanking	40
	Calibration.....	40
5.3.2	Peak/Cont.....	41
	Peak.....	41
	The Peak Cycle	41
5.3.3	Ref Mode.....	42
	Cont.....	42
5.3.4	Blank.....	42

6	OPERATING THE INSTRUMENT	43
6.1	Start Up.....	43
6.1.1	Compressor Start Up	43
6.1.2	Switch On	43
6.1.3	Ignition Successful	43
6.2.1	Required Blanking.....	43
6.2.2	Required Calibration	44
6.3	Sample Measuring.....	45
6.3.1	Measuring in Peak mode	45
6.3.2	Measuring in Continuous mode	45
6.4	Automatic operation	45
6.5	Sample Numbering.....	46
6.5.1	Reset of sample number	46
6.5.2	Repeat sample	46
6.5.3	QC sample.....	46
6.6	Shutdown Procedure.....	46
7	OPERATING HINTS, PRECAUTIONS & LIMITATIONS.....	47
7.1	Hints	47
7.2	Operational Precautions and Limitations	47
7.3	Hazards	48
7.4	Measuring Calcium	48
8	CLEANING AND MAINTENANCE PROCEDURES.....	49
8.1	General.....	49
8.2	Daily Maintenance	49
8.3	Weekly Maintenance	49
8.4	Monthly Maintenance.....	49
8.5	Six Monthly Maintenance.....	50
8.6	Nebuliser	50
8.6.1	Operational Check.....	50
8.6.2	Cleaning the Nebuliser	51
8.7	Cleaning the Mixing Chamber, Burner and Drain	52
8.8	Cleaning the Filters and Glass Chimney.....	53
8.9	Deproteinising or Disinfecting Procedure	54
9	ACCESSORIES, CONSUMABLES & SPARE PARTS.....	55
9.1	Ordering Information	55
9.2	Spares and Accessories	55
9.3	Reagents.....	56
	APPENDIX A	57
	BIBLIOGRAPHY	57
	APPENDIX B	58
	APPENDIX C.....	60
	Sherwood Scientific Product Warranty Statement	61

1

Introduction

1.1 Contacting Sherwood Scientific

Postal address for letters and orders:

Sherwood Scientific Ltd
1 The Paddocks
Cherry Hinton Road
Cambridge
CB1 8DH
UK
Telephone +44 1223 243444
Fax +44 1223 243300

Email info@sherwood-scientific.com

For Certificates of Analysis and Material Safety Data Sheet downloads, contacting Distributors and Technical and Application information on our products go to our website www.sherwood-scientific.com

The following section must be carefully read before unpacking, installing, using, maintaining or repairing the instrument and/or its accessories.

1.2 Using this manual

This manual is structured to allow both quick access to a measurement from the default position of the Instrument (Section entitled Short Form Instructions on page 2) and an in-depth understanding of the Set-up, Operation and Maintenance of these two advanced Flame Photometers.

The information contained in this manual was correct at the time of going to print. However, Sherwood Scientifics' policy is one of continuous product improvement and the right to change specifications, equipment and maintenance procedures at any time, without notice, are reserved. This manual is copyrighted, and all rights are reserved. No part of this manual may be reproduced by any means or in any form without prior consent in writing.

Introduction

continued

1.3 Safety Precautions

The Model 420 and 425 are intended for use by persons knowledgeable in safe laboratory practices. If the instruments are not used in accordance with these "Instructions for use", the protection provided by the equipment may be impaired.

WARNING *The Model 420/425 are designed to be earthed (grounded) through the power supply lead (line cord) for safe operation. For the safety of operating personnel and optimum performance make sure that the instrument is only connected to a 3-pin socket (outlet) that has an effective earth connection. If you are in any doubt about the safety of your electrical supply system consult a competent, qualified electrician.*

There are no user replaceable parts within the instrument. Do not remove the rear cover from the instrument.

Sherwood Scientific Limited and its authorised Distributors consider themselves responsible for the effects of safety, reliability and performance of the Model 420/ Model 425 only if: -

- ** Assembly operations, extensions, re-adjustments, modifications or repairs are only carried out by persons authorised by them.
- ** The electrical installation of the relevant room complies with IEC requirements or the local regulatory code.
- ** The equipment is used in accordance with the instructions for use.

PLEASE NOTE *that no cables neither for power-in nor for signals-out to the printer, computer via RS232 output nor analogue to a chart recorder, nor signal cables from an Autosampler nor any other device should exceed 2.5 metres in length.*

Introduction

continued

1.4 Reagents

Sherwood Scientific supply a wide range of reagents, including standards, diluent and maintenance solutions, for use with the Model 420 and 425 Flame Photometers. Please refer to Section 9.3 for a complete list of the reagents available.

Reference/Lithium Standard

The full benefit of the technology incorporated in the Model 420/425 is utilised in the default mode of operation. This mode, 'Peak' and 'Reference', requires that the blank, standards and samples contain Lithium at the concentration of approximately 100ppm in the final solution that is aspirated. This is best achieved if the diluent contains 100ppm Lithium. That is 100ml of the 1000ppm Li standard solution supplied with the Model 420 (Part No. 001 56 622). Note: 'Not Clinical version' diluted to 1 litre with the diluent described in the following paragraph.

Blank Storage

All solutions should be stored away from direct sunlight, in a cool place (below 25°C/77°F), in an airtight container to prevent evaporation and discolouration. Glass containers should not be used, as they can affect Na concentration levels. Prolonged exposure to the atmosphere must be avoided to prevent evaporation of standard solutions.

Purification

No purification is required for Sherwood Scientific standard solutions.

1.5 Dilutions

The Model 420 and Model 425 are designed to accommodate the analysis of a wide range of samples. The mode in which either instrument operates can be selected to best match the concentration of the elements expected in the samples.

There are three modes, Industrial Mode 100, Clinical Mode 101 and Clinical Mode 102.

Clinical 101 is targeted for the analysis of clinical serum levels of Na, K and Li.

Clinical 102 mode measures Na, K and Li, but is designed for the higher expected concentrations of Potassium in urine.

Industrial mode offers a wider concentration range for Potassium and Lithium.

The user can select the appropriate mode depending on the concentration of elements expected in the samples. Table 1.5.1 below summarises how each mode is designed to suit different combinations of concentrations.

Introduction

continued

1.5 Dilutions continued

	Concentration into the flame (i.e. <i>after</i> dilution)		
	Industrial Mode 100	Clinical Mode 101	Clinical Mode 102
Sodium	0.02 to 40ppm or 0.0009 to 1.8mmol/l or 0.0009 to 1.8mEq/l		
	Range that standard may be set to 1.00 to 10.00 & 10.0 to 199.0	10.0* to 199.0 *if the standard value of 10.0 is selected the result will be reported to two decimal places	
Potassium	0.02 to 20ppm or 0.0005 to 0.5mmol/l or 0.0005 to 0.5mEq/l	0.02 to 2ppm or 0.0005 to 0.05mmol/l or 0.0005 to 0.05mEq/l (concentrations below 10mmol/l or 10mEq diluted 200 times)	0.02 to 20ppm or 0.0005 to 0.5mmol/l or 0.0005 to 0.5mEq/l
	Range that standard may be set to 1.00 to 10.00 & 10.0 to 199.0	1.00 to 10.00	10.00, 11.0 to 199.0
Lithium	0.05 to 20ppm or 0.0007 to 2.9mmol/l or 0.0007 to 2.9mEq/l	0.05 to 0.7ppm or 0.0007 to 0.1mmol/l or 0.0007 to 0.1mEq/l (concentrations below 5.0mmol/l or 5.0mEq/l diluted 50 times)	
	Range that standard may be set to 1.00 to 10.00 & 10.0 to 199.0	1.00 to 5.00	
Calcium	0.2 to 100ppm or 0.005 to 2.5mmol/l or 0.0025 to 1.3mEq/l		
	Range that standard may be set to	1.00 to 10.00 & 10.0 to 199.0	

Table 1.5.1 – Selecting Mode to suit Concentration

Introduction

continued

1.5 Dilutions continued

Check which mode the instrument is in by pressing and holding down 'Blank' until 100, 101 or 102 is shown in the display. Press '+' or '-' in Channel 1 to toggle between modes.

When the desired mode is displayed, press 'Set' in Channel 1.

200 or 201 will be displayed in Channel 1 and any Delay Time will be displayed in Channel 2, see Section 2.9. Press 'Set' in Channel 1 again.

300 or 301 will be displayed in Channel 1 and the Output Voltage displayed in Channel 2, see Section 2.10. Press 'Set' in Channel 1 again.

400 or 401 will be displayed in Channel 1 and the Analogue Damping Coefficient displayed in Channel 2, see Section 2.11. Press 'Set' in Channel 1 again.

The instrument will return to displaying '000' flashing in both channels.

Dilution Ratio

The Model 420/425 are optimised for the following Dilution Ratios: -

In Clinical Mode

Na & K both Serum and Urine*: - 1:200 with diluent described above
(including Li if used in Reference Mode).

Li (Measurement) Dilution Ratio: - 1:50.

In Non-Clinical Mode

The user should ascertain from his sample what is appropriate by reference to the input concentrations listed in the specification in Section 4.

Urine Samples*

The Potassium content of urine samples is some 20 times that of plasma or serum. In the past, it has been necessary to pre-dilute urine samples prior to following a normal dilution procedure with e.g. Model 805. The design of the Model 420/425 however, minimises the need for this pre-dilution and urine samples with a Potassium concentration of 100mmol/l or less can be treated in exactly the same way as plasma and serum samples provided that the appropriate standard is used to calibrate the instrument for the high Potassium value. Samples with a Potassium level greater than 100mmol/l should be pre-diluted 1 part in 5 prior to the normal dilution 1 part in 200.

Table 1.5.2 below shows example dilutions of standards and routine clinical samples to bring the typical concentrations into the working ranges of the Model 420 and 425.

Introduction

continued

1.5 Dilutions continued

Sample type	Instrument mode	Blank solution	Standard solution preparation	Sample preparation
Na & K in Serum	Clinical Mode 101 with Ref facility	1 part diluent concentrate to 999 parts 100ppm Li solution	Sherwood Clinical standard diluted 200 times with the blank solution.	Dilute sample 200 times with the blank solution.
	Clinical Mode 101	1 part diluent concentrate to 999 parts good quality deionised water		

Sherwood Clinical standard prior to dilution contains 140.0mmol/l Na & 5.00mmol/l K, therefore, set the calibration figures: Na to 140.0 & K to 5.00. As the samples underwent the same dilution as the standard the display shows the mmol/l results **in the original sample**.

Printed results show mmol/l units

Sample type	Instrument mode	Blank solution	Standard solution preparation	Sample preparation
Na & K in Urine	Clinical Mode 102 with Ref facility	1 part diluent concentrate to 999 parts 100ppm Li solution	160mmol/l Na & 80mmol/l K standard diluted one part in five then 200 times with the blank solution.	Dilute sample one part in five then 200 times with the blank solution.
	Clinical Mode 102	1 part diluent concentrate to 999 parts good quality deionised water		

The standard contained 160mmol/l Na & 80mmol/l K prior to dilution, therefore, set the calibration figures: Na to 160.0 & K to 80.0. As the samples underwent the same dilution as the standard the display shows the mmol/l results **in original sample**

Printed results show mmol/l units

Sample type	Instrument mode	Blank solution	Standard solution preparation	Sample preparation
Li in serum	Clinical Mode 101 or 102	1 part diluent concentrate to 999 parts good quality deionised water	5.0mmol/l Li standard diluted 50 times with the blank solution.	Dilute sample 50 times with the blank solution.

The standard contained 5mmol/l Li prior to dilution, therefore, set the calibration figures: Li to 5.00. As samples underwent the same dilution as the standard the display shows the mmol/l results **in the original sample**.

Printed results show mmol/l units

Table 1.5.2 – Dilutions of Standards

Introduction

continued

1.5 Dilutions continued

Samples and standards should be diluted with the same batch of diluent, made up of 1 part Diluent Concentrate (Part # 001 56 681) to 999 parts good quality distilled water.

The same batch of diluent should be used to zero the Model 420 and Model 425 and to prepare dilutions of standards and samples. This will prevent variations in water purity affecting the measurements.

Great care should be taken so that contamination does not occur when preparing the samples and standards. Remember that the accuracy of the Model 420/425 is dependent on the accuracy and purity of the Standards and Blank used for calibration.

To aid the dilution of clinical samples Sherwood Scientific produce a Dilutor, the Model 805, which automates the process and gives extremely reproducible dilution ratios and therefore precise results.

Remember when using the Model 805 Dilutor to increase the Delay Time, see Section 2.9.

1.6 BlueNotes

A BlueNotes CDROM is provided with this instrument for loading on a PC running Windows and will extend the instruments capability:-

- Generate reports with sample names and method details.
- Select units of ppm, mg/l, mmol/l or mEq.
- Use either K or Li as the Internal Standard Element.
- Multipoint Calibrations enabling sample concentrations across the detector's dynamic range to be measured.
- All the detectors can be used to determine sample concentrations simultaneously.
- Gains can be easily optimised for sample concentrations.
- Check and automatically correct sample results for any drift.

Full operating instructions for BlueNotes are contained on the CD.

The flame photometer can still be used without BlueNotes as a standalone instrument.

Introduction

continued

1.6.1 BlueNotes Software installation

The BlueNotes 420 Software is supplied on a CD-ROM with a unique 16 character alphanumeric registration code. Insert the CD-ROM into the disk drive of a PC. The software should auto-run and the following window appear.



Click on **Next** to load the software.



Read the license agreement and click **Next**.

Introduction
continued

1.6.1 BlueNotes Software Installation continued



Record the file path that BlueNotes 420 is to be installed to for future reference & click **Next**.

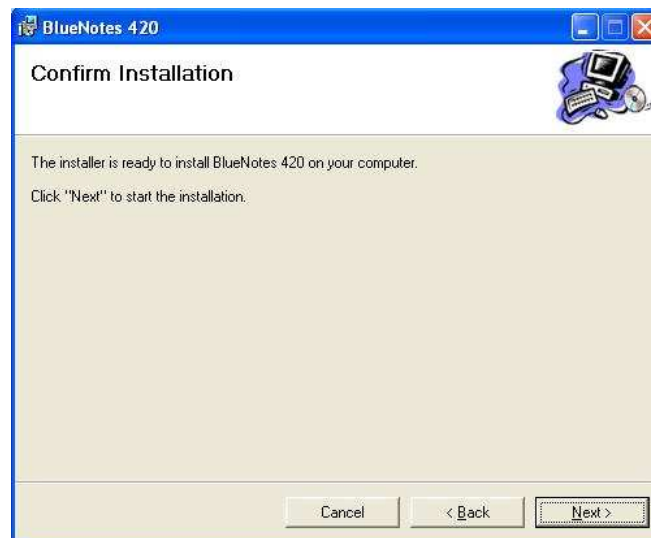

Click **Next** to begin the installation.

Introduction

continued

1.6.1 BlueNotes Software Installation continued

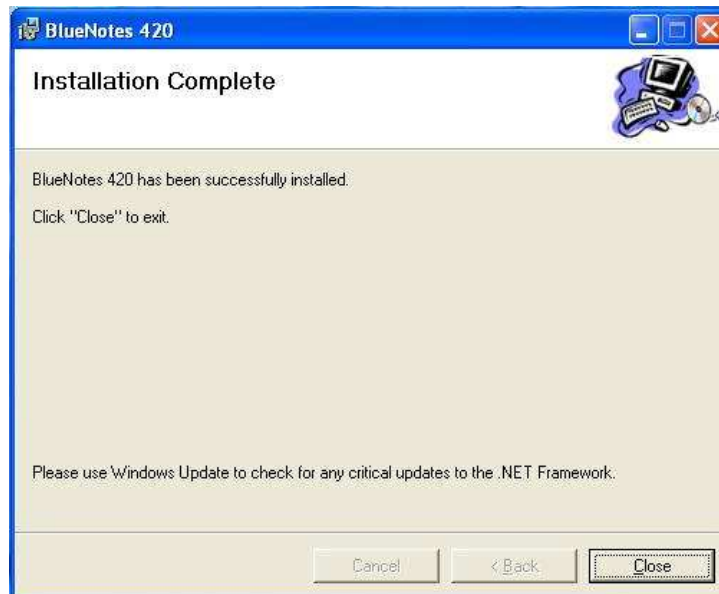
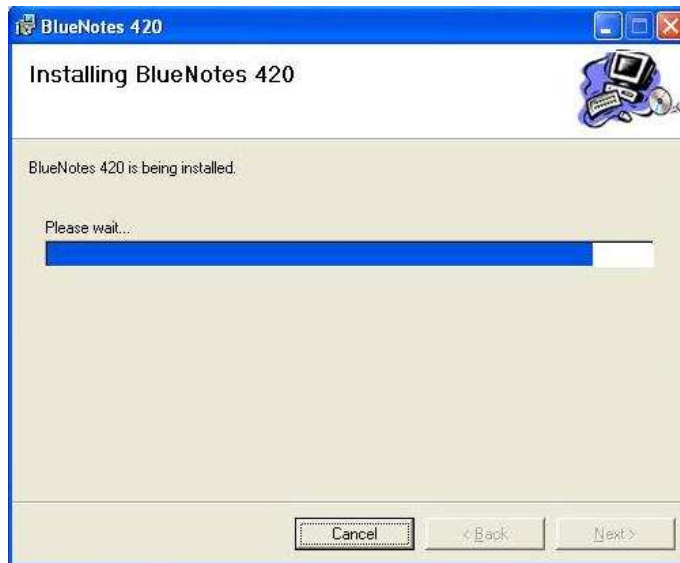

Click **Close** to complete the installation process. The Desktop will now show the shortcut to BlueNotes 420:



Double-click the shortcut to start BlueNotes 420. The first time that BlueNotes is started the License number must be entered, see below.

Introduction

1.6.1 BlueNotes Software Installation continued

continued

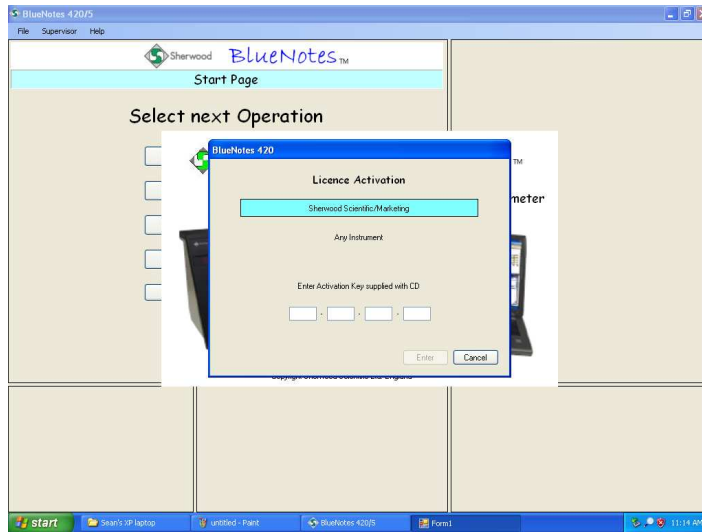

Enter the License Install Key (16 alpha-numeric character code) supplied with the software.

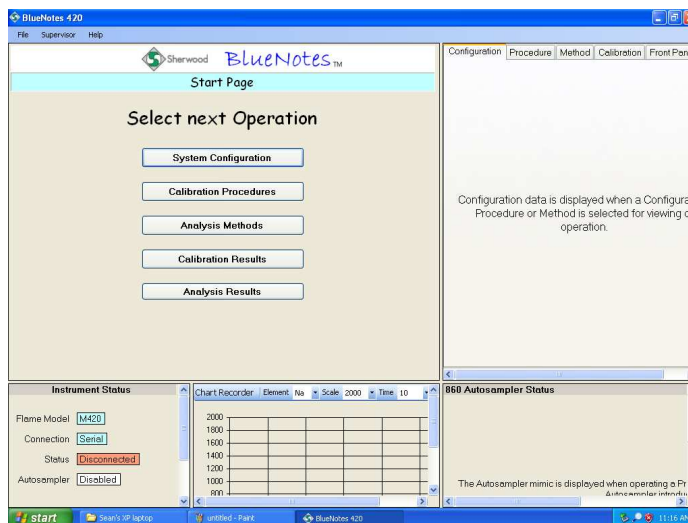
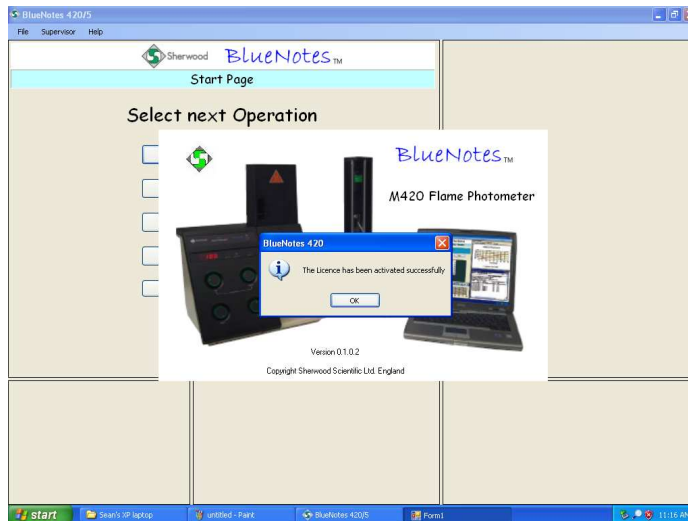

Introduction

continued

1.6.1 BlueNotes Software Installation continued

Click **Help** then **User Guide** to read or print the full BlueNotes Manual for further comprehensive instructions.

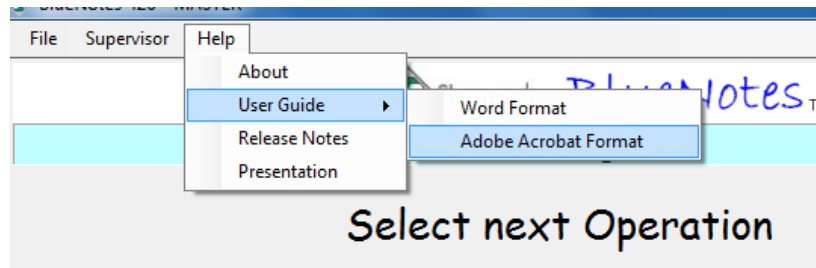

For an easy to follow guide select **Help** then **Presentations** from the Start page, click **Getting Started with BlueNotes420** for a pdf or to start the presentation.

1.7 Warranty

Full warranty terms are listed in Appendix to this manual.

2

Installation

2.1 Location

WARNING *Under no circumstances install the Model 420/425 beneath overhanging cupboards. There must be at least 1 metre of clear space above the chimney.*

For optimum performance, this instrument should be installed in accordance with the following conditions: -

- 2.1.1 The environment must be clean and free from dust.
- 2.1.2 The instrument must be placed on a strong, level worktop, free from vibration. The Model 420/425 requires approximately 500mm x 500mm of bench space, which includes an area in front for solutions and clearance at the rear for fuel and air tubing, with clear access to the mains supply switch.
- 2.1.3. Avoid sites that expose the instrument to direct sunlight or draughts.
- 2.1.4. To meet the specification the ambient temperature must be within the range +10°C to +35°C and the maximum relative humidity must not be more than 85%, non-condensing.

2.2 Services Required

Electrical Supply

An A.C. supply between 90V and 240V $\pm 10\%$, at 50Hz or 60Hz, is required for the Model 420 and 425. The instrument is powered from an external power supply, which will accommodate these voltages without any need to adjust the instrument.

Fuel

A supply of Propane, Butane or Propane/Butane mixture regulated at the cylinder to 2.1kg/cm² (30psi), flow rate at least 0.4 litres per minute.

(NB. Propane only, gives the best results for Ca on the Model 425).

Primary regulators to fit cylinders are available from Sherwood Scientific, regulators are available as optional accessories, refer to Section 9.2.

Air

A supply of clean, dry, oil-free air at 1kg/cm² (11psi), flow rate 6 litres per minute. A suitable air compressor is listed in Section 9.2.

Waste Container

A sink or waste container sited to the right of the instrument will ensure the minimum length of waste tubing. Do not use a waste container with high sides, as this will cause the drain tube to be lifted above the level of the constant head drain.

Installation

continued

2.3 Unpacking

1. Unpack the instrument and accessories.
NOTE The Model 420/425 weighs 9.5kg; follow safe lifting techniques.
2. Check all items for damage.
3. Check that all the items on the Accessory List have been delivered. Contact your Sherwood Scientific distributor if you have any problems.
4. The Model 420/425 is shipped with the following items: -

Accessory List

CAT. NO.	DESCRIPTION	QUANTITY
001 72 043	Air tubing, nylon reinforced	2 metres
001 72 114	Fuel tubing	2 metres
400 22 002	Tube Drain - all flames up to #20585 & after #28016	1 metre
001 53 420	Universal external power supply	1
100 99 010	Nebuliser cleaning wire, pack of 3	1 pack
001 31 076	'O' ring, spare for mixing chamber	1
420 08 102	Nebuliser	1
400 22 003	Nebuliser inlet tube, polythene, 150 mm	1
425 91 001	Operators manual M420/M425	1
926 09 052	RS232 Output Cable	1
001 08 718	'Unex' tubing clamp	4
001 56 100	Standard Solution containing 140.0mmol/l Na, 5.00mmol/l K and 1.5mmol/l Li	1 x 100ml*
001 56 603	3 Molar Lithium Standard, 1 x 100ml	1 x 100ml*
001 56 622	Lithium 1000ppm Standard, 6 x 100ml	1 pack **
001 56 620	Sodium 1000ppm Standard, 6 x 100ml	1 pack **
001 56 621	Potassium 1000ppm Standard, 6 x 100ml	1 pack **
001 56 623	Calcium 1000ppm Standard , 6 x 100 ml	1 pack ***
410 92 001	CDROM, Flame Training Guide	1
420 66 000	CD, BlueNotes 420 Software	1

* supplied with Clinical instruments.

** supplied with Industrial instruments.

*** supplied with Model 425.

Installation

continued

2.4 Assembly

EQUIPMENT REQUIRED: -

'Poizidriv' (cross head) screwdriver 1PT

Flat blade screwdriver.

To assemble the instrument, proceed as follows: -

1. Lift off the chimney cap from the chimney assembly and lift out the glass chimney. Remove any packing material from inside, making sure that there are no small pieces left within the chimney.
2. Replace the glass chimney with the clear strip at the bottom and refit the chimney cap on top of the chimney.
3. Remove the Nebuliser (420 08 102) from its box and push the barbed connector into the end of the air tubing (item 3, figure 2.1). Fit the Nebuliser (item 1, figure 2.1) to the mixing chamber and position the retainer (item 2, figure 2.1) to lock it into position. Locate the Nebuliser inlet tubing (400 22 003) and fit over the narrow tube in the front of the Nebuliser.

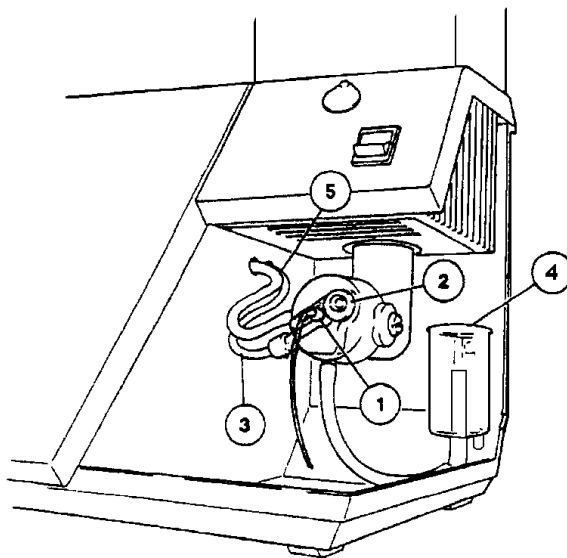

Figure 2.1 Mixing Chamber

1. Nebuliser, 2. Nebuliser retainer, 3. Air tubing, 4. Constant head & drain, 5. Fuel tubing, 6, End Cap, 7, Securing Screw.

4. Connect the length of rubberised fuel tubing (001 72 114) between the inlet connector on the internal regulator, (item 5, figure 2.2) and the regulator at the cylinder outlet connector. Secure with 'Unex' tubing clamps (001 08 718).

Installation

continued

2.4 Assembly continued

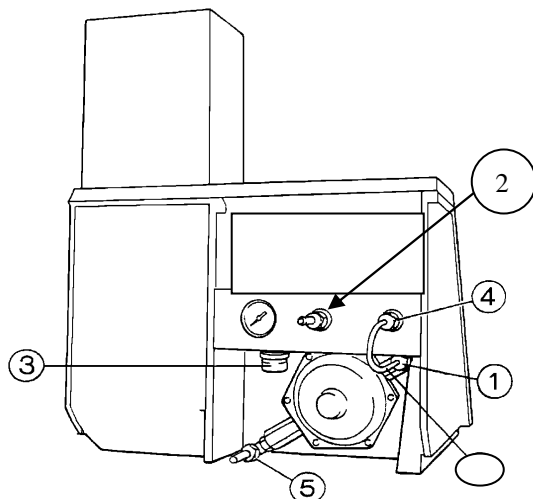

Figure 2.2 Rear Connections for Services

1. Regulator outlet connector, 2. Air inlet, 3. Air regulator adjuster, 4. Gas inlet connector, 5. Gas Regulator inlet connector.

5. Turn on the fuel supply and check all connectors for leaks, using soap solution. Do not use the instrument until you are satisfied that the installation is leak proof.
6. Connect the air compressor to a suitable mains supply.
7. Connect the length of reinforced hose (001 72 043) between the air compressor outlet and the air inlet connector on the rear panel (item 2, figure 2.2). Secure both ends with 'Unex' tubing clamps (001 08 718).

Installation continued

2.4 Assembly continued

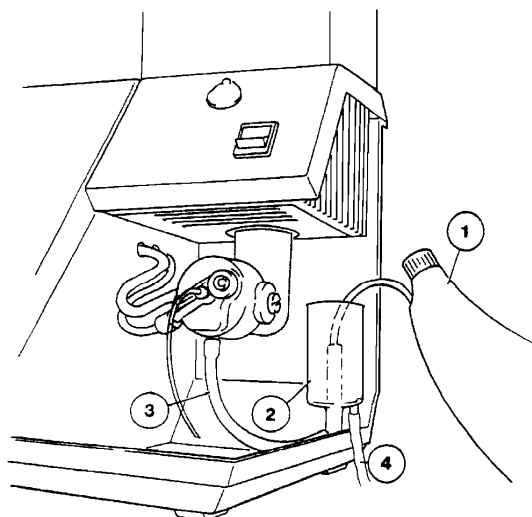

Figure 2.4 Filling the 'U' tube

Wash bottle, 2. Constant head & drain, 3. 'U' tube, 4. Drain tube, 5. Spring Clip

- 8 Fit the constant head & drain (Gas Trap) on the two retaining screws (see below). Fit the drain tubing (400 22 002) (item 4, figure 2.4) to the outlet on the constant head and drain. If necessary connect a suitable length of tubing (not supplied), to extend the drain tubing to carry waste to a sink or other drain receptacle. The downward flow of waste must not be restricted.



- 9 Make sure that the constant head and drain is pushed fully down on its mounting screws. Use a wash bottle (item 1, figure 2.4) to fill the 'U' tube with deionised water. Sufficient water should be used to purge the tube of air. Allow excess water to flow back into the drain.

IMPORTANT *Do not continue until you are satisfied that the 'U' tube has been completely filled with water, and is purged of air.*

Installation

continued

2.4 Assembly continued

10. Plug in the external Power supply to the inlet shown in Fig 2.3.

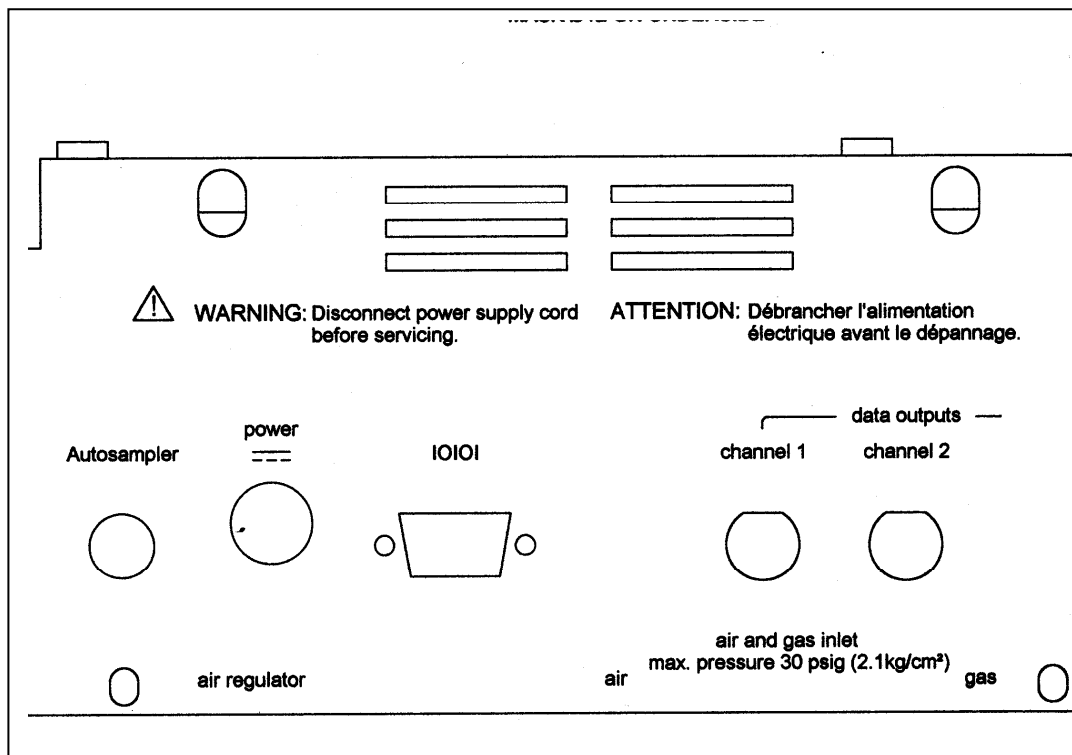

Figure 2.3 Rear Panel

11. Fit a suitable a.c. supply lead to the External Power supply.

CAUTION *Ensure that the green/yellow earth connector in the a.c. supply lead is connected to a properly grounded earth point, the brown lead is connected to the Line terminal (L) and blue lead is connected to the Neutral terminal (N).*

12. If necessary, set the "1/0" power switch (below the chimney) to the 0 position. and connect the plug to a convenient supply socket.
13. If no printer/computer or chart recorder interfacing is required proceed to Chapter 6 of this manual.

Installation

continued

2.5 Connecting Peripheral Devices

Printer

Sherwood Scientific can supply a serial printer set up to operate with the Model 420 & Model 425 (Part # 473 86 009). This should be connected to the cable supplied with the instrument, the other end of which is connected to the rear panel in the RS232 socket as shown in Fig 2.3.

Computer

The same serial outlet and cable can be connected to a computer, which, through the "terminal" function, will display a .txt file identical to the printer display.

Sherwood Scientific now supply an Excel spreadsheet program which can take the output from the Model 420 or model 425 directly into a spreadsheet for further manipulation.

This program can be downloaded from the Sherwood Scientific Website

www.sherwood-scientific.com

A computer connected to the instrument with the serial cable or via a USB to Serial Adapter (not supplied) and a serial cable is required to run the BlueNotes for 420 application offering additional facilities. See Section 1.6.

Analogue Devices

The Model 420/ Model 425 have one set of analogue outputs corresponding to each channel.

The left-hand coaxial socket takes the output from Channel 1 and the right-hand socket from Channel 2. The appropriate voltages are set as described in Section 2.10.

Auto-sampler

The Model 420/425 can be augmented with an Auto-sampling device to form a fully automatic analytical system. The Model 860 Autosampler has 40 positions for serum and other clinical samples and is used in conjunction with the Model 805 Automatic Diluter.

The Autosampler is supplied with a signal cable which is plugged into the Rear panel as shown in Fig 2.3.

Installation

continued

2.6 Setting Date and Time

Press and hold 'Print' during the start-up sequence to put the instrument into Date and Time Mode, which will be operative as soon as the flame has lit. Ch1 displays the date format "day month year".

Display day as 'd 10'.

Adjust with '- or +'.

Press 'Set' to confirm and move on.

Display month as 'n 05'.

Adjust with '- or +'.

Press 'Set' to confirm and move on.

Display year as 'y 98'.

Adjust with '- or +'.

Press 'Set' to confirm and move on.

Display hour as 'h 13'.

Adjust with '- or +'.

Press 'Set' to confirm and move on.

Display minutes as 'n 40'.

Adjust with '- or +'.

Press 'Set' to confirm and move on.

Automatically sends output as in format: -

day = 10 month = 05 year = 98 hours = 13 minutes = 40

The Model 420 /425 now reverts back to the point in the operating sequence waiting for the first blank.

Installation

continued

2.7 Setting Filter Factors

The Model 420 uses three detectors permanently connected; one each for Sodium, Potassium and Lithium. (NB The Model 425 has four detectors with the extra Calcium channel).

Each detector has an interference filter of the appropriate wavelength fitted in front of it. The filters have a unique transmittance factor, which is measured during construction and entered into the software. These values are held in a battery-backed memory. If the battery fails, shown by Error Code 'E62', it is necessary to re-introduce the factors by the following procedure. The correct Filter Factors can be obtained from Sherwood Scientific by reference to the Serial number.

1. Press then hold down the 'Set' key, the 'Blank' key and the 'Print/Measure' key together and wait for the 'beep'. After a few seconds, the top display will show 1000 and the lower display will show F1.
2. Adjust the top display using the '+' and '-' controls to the value for the Sodium (Na) filter. Press 'Set' in the top display to fix the value. This will then reveal 1000 in the top display and F2 in the lower display.
3. Repeat step 2 for F2 Potassium (K) value.
4. Repeat step 2 for F3 Lithium (Li) value.
5. Repeat step 2 for F4 Calcium (Ca) value

2.8 Units

Mode 101 and 102 both print the units of mmol/l when the instrument is connected to a serial printer. Mode 100 does not print any units.

NOTE: - Changing the mode of the Model 420 and Model 425 not only affects any units printed, but also the optimal analysis ranges, see Table 1.5.1, Section 1.5.

1. After switch on or at any time press and hold down the 'Blank' key until '100', '101' or '102' is displayed in Channel 1.
2. To remove the units change the display by pressing the '-' button to toggle to 100. For the correct clinical range selection (101 or 102), see Table 1.5.1, Section 1.5.
3. Press 'Set' to accept the new value.
4. The display will now show 200 on Channel 1, which allows sample delay see Section 2.9 (below).

Installation

continued

2.9 Setting Sample Delay (in Peak mode)

In Peak mode, the Model 420 and Model 425 have a default delay of 19 seconds after pressing 'Cal' or 'Print' before the Peak-seeking algorithm initiates; this allows the calibrant/sample to stabilise in the flame. This time delay can be adjusted by the user to accommodate, for example, a diluter where there is a considerable delay before such stabilisation can take place. (The length of this delay can be ascertained by running the instrument in continuous mode and observing the exact time between introducing the sample and the stabilisation of the display).

1. Following the setting of Clinical or Industrial Mode described in Section 2.8 (above) the display reads '200' in Channel 1.
2. Press '+' in Channel 1 to display the delay value in Channel 2.
3. If the default delay of 19 seconds is acceptable press 'Set'.
4. If not, adjust the value in Channel 2 by pressing the '+' key until the value is correct and then press 'Set' on Channel 1.
5. The display will now show '300' on Channel 1. Which allows the output voltage to be adjusted, see Section 2.10 (below).

NB *It is essential while operating in Peak Mode to aspirate the standard or sample before pressing "Cal" or "Print" to take advantage of this facility.*

2.10 Setting the Output Voltage

The output voltage is the maximum voltage measured when at full scale. This can be set from 0.05 to 7.5.

1. Following the setting or acceptance of the sample delay as described in Section 2.9, Channel 1 display reads '300', and Channel 2 '1.0' (default).
2. Adjust the output voltage in Channel 2 using the '+' or '-' buttons.
3. Accept the required output voltage by pressing 'Set' in Channel 1.

(NB The Model 425 has an additional feature, which allows the analogue outputs to be set for blank and "span" by passing the normal calibration protocol. This feature can be invoked by adjusting the 300 to 301 by the '+' key before pressing "SET" as above).

2.11 Setting the analogue damping coefficient.

- 1 After adjusting the voltage level in section 2.10 above, the Model 420 and 425 shows "400" in the Channel 1 display.
- 2 To adjust the level of damping in the analogue output adjust the channel 2 display from 1 (No damping) to 20 (Maximum Damping) by use of the '+' & '-' keys. Press "SET".

The displays will return to flashing '000' and the blanking and calibration procedures can begin again.

3

Principles of Operation

3.1 Application of Flame Photometry

Prior to the advent of flame photometry, Sodium and Potassium were typically determined gravimetrically after the precipitation of relatively insoluble salts such as Sodium Uranyl Zinc Acetate (Ref. 1) and Potassium Chloroplatinate (Ref. 2). As with all chemical methods for these two elements, there were cross interferences and also interference from other ions such as NH_4^+ . Many analytical steps such as protein precipitation or ashing of the sample were involved with all the attendant losses and inaccuracies and the complete procedures required many hours.

In many applications, particularly in clinical situations, rapid availability of results is of prime importance. By flame photometry, both Sodium and Potassium results on a single sample can be available in less than 5 minutes of the sample reaching the laboratory. With the availability of the Li Reference Mode, accurate results can be achieved while the instrument is still warming up. A simple dilution step is all that is required; therefore sample handling, losses and inaccuracies are at a minimum (Ref. 3 to 10).

3.2 Principles of Flame Photometry

When a solution is aspirated into a low-temperature flame, in an aerosol, each droplet of water evaporates leaving a solid core of the residue of evaporation. The core further breaks down to the molecular level and provided the molecules are not too refractory, progress to form atomic species. The atom then is excited by the flame and its electron temporarily moves to a higher energy state.

When the electrons return to the ground state, they lose the excitation energy and a discrete wavelength of visible light is emitted, characteristic of the atom. The emitted light can be isolated from other light wavelengths by an optical filter. The amount of light being emitted is proportional to the number of atoms in the flame, and it follows, the concentration of that atom in the original solution. The amount of light emitted can be measured by a suitable photodetector.

The photodetector generates an electrical signal which is amplified and displayed on a digital readout.

The Sherwood Scientific Model 420 Flame Photometer is a Dual Channel low-temperature Flame Photometer designed to be used for the simultaneous determination of Sodium (Na), and Potassium (K) in Clinical and Industrial samples. The Model 420 also has the benefit of an Internal Standard using a Lithium (Li) signal to eliminate interferences due to variation in dilution ratios (where a continuous Diluter is used) as well as variability in the characteristics of the flame photometer itself.

The Model 420 can also function as a Single Channel instrument for the determination of Na and K including reference mode and Li without reference mode.

Principles of Operation

continued

3.2 Principles of Flame Photometry continued

The Model 425 is a Four element Flame Photometer where the user can choose to determine two elements at a time:-

Na & K with and without Li Internal Standard
 Na & Ca with and without Li Internal Standard
 Na & Li
 K & Ca with and without Li Internal Standard
 Li & Ca

or just one element:-

Na with or without Li Internal Standard
 K with or without Li Internal Standard
 Li
 Ca with or without Li Internal Standard

3.3 The Internal Standard Mode

When the Internal Standard is invoked with the 'Ref' mode, this uses the signal from the Li detector to scale the readings from the other detector(s) to allow for external effects such as drift, flame disturbances, changes in dilution, nebuliser uptake rate, etc.

It works by adding a known concentration, (C_o), of Li to the Blank, and the diluent of the Standard solutions and the Sample. The Li signal is constant at C_o if all the external effects are constant. If the Li signal changes it does so because of flame and instrument variables. By introducing a factor based on the reference Li measurement, we can remove many of these variables from the analysis of Sodium and Potassium.

The Li reference factor is assigned a value of 1.000 at the time of calibration. This factor is shown on the print-out each time an analysis is performed, which indicates the amount of change due to drift, aspiration rate etc. since the calibration was made. The limit of $\pm 20\%$ can be corrected for and if the factor exceeds this limit an error is indicated which tells the operator to clean the aspirator and recalibrate.

To use this mode the **blank**, **calibration standard**, and **samples** will have to be in a solution that contains Lithium of a constant concentration, C_o , in the diluent. See Section 1.4 Reagents.

4 Performance Characteristics &

Specifications

The Model 420 can be ordered in two versions: the Model 420 Clinical (475 42 000) and the Model 420 Industrial (475 42 100). The following specification applies to the Clinical version. The Model 425 is offered in the non-clinical mode although clinical standards can be supplied separately see Section 9.

The specification of the Industrial version is included as an appendix to this manual.

4.1 Readout

Dual three-digit light emitting diode (LED) display, 12.5mm high.
Display ranges 0 to 199.9.

NOTE If negative values are displayed the instrument is operating outside of the recommended measurement range or it is in between samples in continuous reference Mode as the Lithium reference is absent.

4.2 Measurement Ranges

	Model 420	Model 425
Elements analysed	Na, K (with Li Int Std) Li	Na, K& Ca (with Li Int Std) Li
Readout	No Units or mmol/l	No Units or mmol/l
Sensitivity for 100 displayed	Na and K= 0.5ppm, Li = 2 ppm	Na and K= 0.5ppm, Li = 2 ppm Ca = 5ppm
Reproducibility	<± 1%	<± 1%
Reading Stabilisation	Variable software command	Variable software command
Recorder output	2 outputs 50mV-7.5V via software command	2 outputs 50mV-7.5V via software command
Air Supply (required)	6 liters/min @ 11 psi oil and moisture free	6 liters/min @ 11 psi oil and moisture free

The working ranges of concentrations of elements entering the flame of the instrument are:-

		Concentration entering the flame i.e. after dilution					
		ppm or mg/l		mmol/l		mEq/l	
		Detection limit	Upper range limit	Detection limit	Upper range limit	Detection limit	Upper range limit
420	Na	0.02	40	0.0009	1.8	0.0009	1.8
	K	0.02	20	0.0005	0.5	0.0005	0.5
	Li	0.05	20	0.0007	2.9	0.0007	2.9
425	Na	0.02	40	0.0009	1.8	0.0009	1.8
	K	0.02	20	0.0005	0.5	0.0005	0.5
	Li	0.05	20	0.0007	2.9	0.003	2.9
	Ca	0.2	100	0.005	2.5	0.0025	1.3

Performance Characteristics and Specification

continued

4.2 Measurement Ranges continued

NOTES

The instrument's mode can be selected to best match the concentration of Potassium and Lithium expected in the sample. Refer to Table 1.5.1 Section 1.5 as a guide to selecting modes.

Refer to Table 1.5.2 Section 1.5 for examples of dilutions for clinical samples.

When working stand alone (without BlueNotes) the Model 420 and Model 425 are single point calibration instruments. Sherwood would not recommend working outside the above ranges.

4.3 Specificity

For Na, K and Li measurements, interference will be less than 0.5% from a concentration of Na, K, and Li, equal to the concentration of the element under test.

For calcium, there is a significant background interference from Sodium:

The emission of a Calcium solution will be increased in the presence of Sodium in the solution. Contact Sherwood Scientific for methods for accounting for the interference.

4.4 Accuracy

Linearity

Better than $\pm 1\%$ measured at mid-range, when standardised at the following concentrations: - 140.0mmol/l Na; 5.0mmol/l K; 1.5mmol/l Li diluted 1 in 200.

Drift

NOTE A minimum 15 minutes warm up must be allowed to meet the drift specification, refer to Section 4.5.

Na < 2mmol/l in 10 minutes at all ranges

K & Li < 0.1mmol/l in 10 minutes at 5.00mmol/l

NB *In Reference Mode this drift is greatly reduced.*

Reproducibility

Using Peak mode

< 2.0% CV for 20 consecutive readings of the same bulk sample, aspirating sample for 20 seconds then 10 seconds of air.

Using Peak with Ref (Internal Standard) Mode

< 1.0% CV for 20 consecutive readings of the same bulk sample, aspirating sample for 20 seconds then 10 seconds of air. With a delay of 30 seconds see section 2.9.

Performance Characteristics and Specification

continued

4.5 Warm Up

To achieve the stated specification the flame must be alight for a minimum of 15 minutes, with diluent being aspirated.

4.6 Sample Requirements

Sample Types

Serum	Na	0 to 199.9mmol/l
		(Model 420 and Model 425 incorporate Linearisation in their software to correct for Na self absorption)
	K	1.00 to 10.00mmol/l
	Li:	1.00 to 5.00mmol/l
Urine	Na	0 to 199.9mmol/l
	K	10.0 to 120.0mmol/l

These are original sample concentrations before dilution.

Dilution Ratios	Na/K	1:200	Serum
	Na/K	1:5	Urine
	Li	1:50	

Type

Is dependent on the application. However, samples should not be highly viscous or non-homogeneous.

Method of Presentation

The diluted sample is presented to the nebuliser from a sample cup, test-tube, or other suitable container.

Alternatively, a continuous flow diluter, Model 805, can be used and the undiluted sample can be presented to the Dilutor

The Model 420 and Model 425 can now be used with the Model 860 Auto-Sampler and Model 805 Diluter giving a fully automatic Clinical System for Na and K analysis.

Volume

The maximum diluted sample volume required for 20 seconds aspiration is 2ml, which gives the minimum sample volume as 10µl. 50µl for the Model 805 and 0.2ml for the Model 860 system.

Performance Characteristics and Specification

continued

4.7 Chart Recorder Output

Can be adjusted for 100.0 display from 0.05V to 5.0V.

4.8 Environmental Conditions

Temperature

Operating +10°C to +35°C

Transportation –10°C to +45°C

The instrument specification will be unaffected by an ambient temperature change of 4°C (or less) per hour, within the range +10°C to +35°C, with a maximum of 7°C shift during 8 hours.

Humidity

Operating: - 85% maximum at +35°C

Transportation: - 95% maximum at +45°C (non condensing) .

For use in these conditions use the Compressor Model 855 with a water-cooled trap.

4.9 Power Requirements

Voltage

90V to 132V or 198V to 264V, 50/60 Hz

Power

20 VA.

4.10 Fuel

Propane, Butane or Propane/Butane mixture. (Not Natural Gas, as the Model 420/425 features a fully automatic ignition system which requires a constant pressure gas supply). All fuels to be free of heavy hydrocarbon deposits and regulated at the cylinder to approximately 2.1kg/cm² (30psi). **NB.** for the Model 425 Calcium requires Propane/Air flame.

Performance Characteristics and Specification

continued

4.11 Air

A supply of clean air at a pressure of 0.9kg/cm² (11psi) at 6 litres/minute, as supplied by a Model 851 Air Compressor.

The stability of the readings from the Model 420 and Model 425, especially at high gain, depends on a smooth aspiration of the sample; this can be disturbed by droplets of condensation coming from the air compressor where the compression/expansion causes significant condensation in humid atmospheres. If condensation problems arise a Model 855 Air Compressor should be used, which has a water separator fitted.

Air Compressors are listed in Section 9.2.

4.12 Size

Overall, including chimney and rear panel connectors: -

510mm high
390mm wide
345mm deep.

4.13 Weight

9.5kg, instrument only.

5

Description of Instrument

5.1 Front Panel Controls and Indicators

Model 420/425 Controls	Primary Function	Secondary Function	Tertiary Function	Quaternary Function
Blank	Reset all channels to zero	Reset instrument to default mode	Enter set-up mode for Units, Delay, Voltage	Enter set-up Mode for Filter factor
Channel selector	Selects single and dual channels for display and printing			
Mode Selector	Selects Peak, Lithium Reference and Continuous in various combinations			
Measure/Print	Initiates Measure cycle in Peak Mode	Initiates Print in Continuous Mode	Enter set-up mode for Date and Time	Enter set-up Mode for Filter factor
Channel 1 Set	Initiates Calibration procedure	Confirms Calibration Value	Confirms Set-up choices	
Channel 2 Set	Initiates Calibration procedure	Confirms Calibration Value	Enter Set-up Mode for Filter Factor	Software version

5.1.1 Controls

'-' 'Set' '+'

(Feedback beep confirms the action)

Primarily used in the calibration process.

Secondary functions include: -

date and time setting

Filter Factors and other settings

When Pressed during a measurement session the instrument will automatically interrupt the measurement and require 'Blanking' and 'Calibration'.

Description of Instrument

continued

5.1.1 Controls continued

Blank

(A feedback beep confirms the action).

Forces the instrument to zero all channels.

Must be used at start-up and after a change of 'Peak/Cont', 'Single/Dual' or element selection.

A **short** press may be used at any time during a measurement session to reset the blank while aspirating the blank solution.

A **long** press at any time will reset to default settings and put the instrument into start-up blanking mode and into Set-up mode.

Single/Dual and Element Selection

Used at start-up to choose 'Single' or 'Dual' channel operation.

Used to select particular elements by "toggling" through the sequence: -

The Model 420	The Model 425
"Na & K"	"Na & K"
"Na & Li"	"Na & Ca"
"Na"	"Na & Li"
"K"	"Ca & K"
'Li'.	"Ca & Li"
	"Na"
	"Ca"
	'K'
	"Li"

When in "Ref" Mode with Li Internal Standard, Li cannot be measured and will not be selectable.

Peak/Ref/Cont

Used at start-up to choose the measurement mode, must be chosen before Blanking.

'**Peak**' has the instrument sense when a steady reading has been achieved and freeze that reading.

'**Ref**' uses signals from the Lithium channel as an internal reference. Can be used with 'Peak' or 'Cont'.

'**Cont**' displays readings in real-time.

Sequence is: -

"**Peak & Ref**" (Default Mode), "**Cont**", "**Cont & Ref**", "**Peak**".

Description of Instrument

continued

5.1.1 Controls continued

Measure

(A feedback beep confirms the action).

Used to initiate the measurement and will send an output to the RS232 serial port (connected to a printer, computer or data logger) at the end of the measurement process in "Peak" mode. In 'Cont' mode it sends an instantaneous value to the Printer. The sample must be introduced before 'Print' is pressed. Short, long or double presses produce different sample identification in output format (see Section 6.5).

5.1.2 Description of Indicators

All of the front panel indicators are LED's mounted behind a flexible plastic overlay which provides protection from the laboratory environment. Some windows are plain rectangles others are text legends.

Cal (Ch1 & Ch2)

'Cal' on a given channel is illuminated when the instrument automatically goes into calibrate mode after a successful blanking.

"Cal" Starts flashing after the Calibration sequence has been initiated 'Cal' changes from flashing to steady when either: -

In 'Cont' mode.

'Set' is pressed for the second time in the calibration process (see Section 7.2).

In 'Peak' mode.

The internal part of the calibration process is complete.

Single

Is steadily illuminated when in 'Single' (Ch1) or 'Single' (Ch2) modes.

Dual

Is steadily illuminated only when in 'Dual' mode.

Peak

Indicates that 'Peak' mode has been selected.

Ref

Indicates that the 'Reference' mode has been selected.

'Peak' and 'Ref' can both be steadily illuminated at the same time.

Description of Instrument continued

5.1.2 Description of Indicators continued

Cont

Indicates that 'Continuous' measurement mode has been selected. 'Cont' and 'Ref' can both be steadily illuminated at the same time.

Measure

Indicates that the instrument is in 'Measurement' mode. "Measure" flashes during "Peak" measurement process before completion.

Flame On

Indicates that an internal sensor has detected the presence of the flame, absence of illumination after the ignition process will be accompanied by the error message 'E61' on the measurement displays.

Power On

Indicates that the instrument is on and connected to the proper electricity supply.

5.2 Rear Panel Controls and Connections

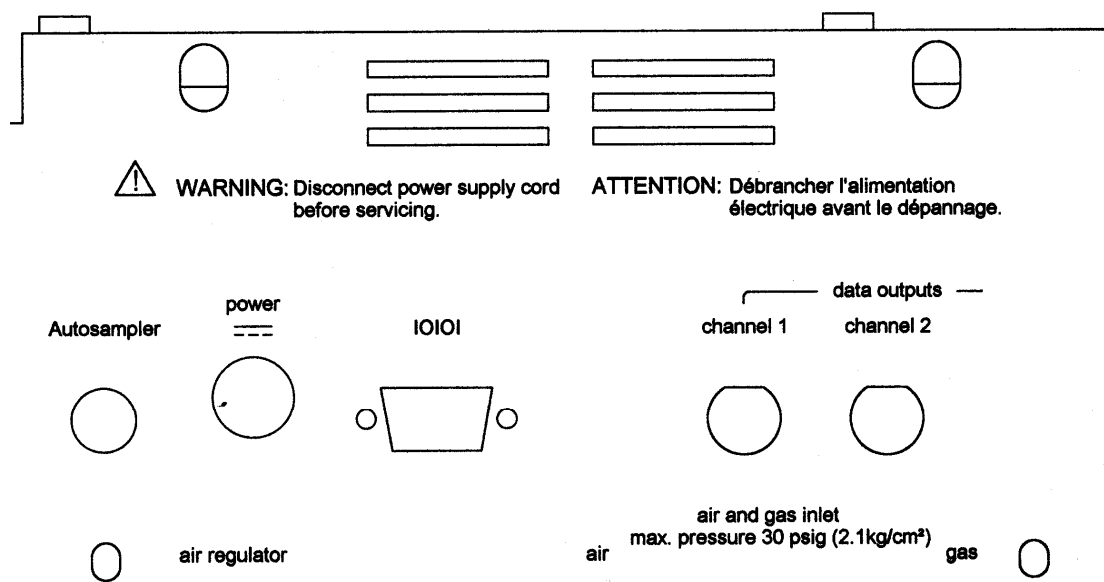

Figure 2.3 Rear Panel

Description of Instrument

continued

5.2 Rear Panel Controls and Connections continued

Channel 1 & 2 Data Outputs

Both these outputs carry a variable voltage signal (set as indicated in Section 2.10 and 2.11) equivalent to a reading of 199.9 on the two channel displays.

When either instrument is the Clinical Mode and when the display is in the lower range for Potassium and Lithium where the display is indicating x.xx the output is equivalent to 19.9.

The outputs can be connected to an Analogue/Chart recorder using coaxial plugs (not supplied).

RS232/Printer Output

This is a standard 9way output and the printer output cable (supplied) should be connected here. The other end of the cable is a 9 pin standard RS232 connector for serial printers and other data logging devices.

External Device Output

This is another 8-pin DIN connector which enables the instrument to be connected to the Model 860 Autosampler.

Power

The Model 420 and Model 425 are supplied with an Universal External Power supply which can accommodate 90-240V AC input.

Gas

¼-inch fuel inlet connector to the instrument, permanently connected to the in-built regulator inlet (item 5, figure 2.2). The instrument will operate satisfactorily on Propane and Butane.

Air

¼-inch connector for the air inlet tubing to the instrument (item 2, figure 2.2), from the air compressor outlet. See Section 4.11 for pressure and flow rate specifications.

Air Regulator

Control to adjust the pressure of the air supply (item 3, figure 2.2). The air pressure gauge provides a visual indication of the air pressure.

Description of Instrument

continued

5.3 Operating Modes

Operating Modes for Model 425 are additional and in italics.

5.3.1 Single/Dual Mode

Refer to Section 5.1.1 for the function of the 'Single/Dual' button and to Section 5.1.2 for its status indicators 'Single', 'Dual'.

Single

The Model 420 has 3 detectors one each for Na, K and Li, permanently producing signals from the light of the flame. The option of running in single channel mode has been provided and is selected by use of the 'Single/Dual' button mentioned above. This allows the user to choose not only between 'Single' or 'Dual' operation but also between Ch1 and Ch2. to access K or Li.

For the Model 425, there are 4 detectors the additional detector is for Calcium, which can be selected as a single element.

Dual

This mode allows the user to simultaneously measure two elements in the same sample. For clinical use, this guarantees better than a 100% time saving compared with a single channel instrument.

Ch1 will display Na.

Ch2 can be either K or Li unless in Ref. mode when Li is used as the reference element and cannot also be displayed.

Calcium in combination with Na will be shown on the lower display. When in combination with K (or Li when not in "ref" mode) it is in the upper display.

Blanking

Affects all channels so it will operate in the same way regardless of which of these modes has been selected.

Calibration

If operated in Dual mode, both channels must be calibrated before measurements can begin, but it does not matter which channel is calibrated first.

Description of Instrument

continued

5.3 Operating Modes continued

5.3.2 Peak/Cont

Refer to Section 5.1.1 for the function of the 'Peak/Cont' button and to Section 5.1.2 for its status indicators 'Peak/Ref/Cont'.

Peak

This mode is intended to give the user a frozen measurement value on the instrument display. This not only removes subjectivity from the user but also offers a much greater advantage by enabling automation of sample delivery and collection of results.

The Peak Cycle

The full sequence of the peak process is as follows: -

The cycle commences with the introduction of a new sample, quickly followed by pressing 'Measure'.

The instrument starts a built-in delay (which can be varied see Section 2.9) as soon as a press of 'Measure' has been registered, (whether a short, long or double press does not matter); readings are displayed on all operative channels. When the values satisfy the peak detection algorithm the display(s) freeze and the "Measure" indicator will become steady. A single beep will sound and a valid measurement value will be output to the RS232 serial port.

The cycle cannot re-commence until the previous values flash and the measure indicator is steady.

Then a new sample can be aspirated and "Measure" is pressed.

If the cycle has timed out for the previous sample before the algorithm was successful on all operative channels, "measure" will flash and "E22" will be showing on at least one display.

(NB a full list of all codes is printed as Appendix B).

Description of Instrument

continued

5.3 Operating Modes continued

5.3.3 Ref Mode

Ref. stands for internal reference. This mode uses the signal from the Li detector to scale the readings from the other detector(s) to allow for external effects such as flame disturbances, changes in dilution, nebuliser uptake rate, etc.

For a full explanation see Section 3.3.

To use 'Ref' mode make sure Li is not selected and the calibration and measure samples will have to be in a solution with the known concentration (we recommend 100ppm Li), C_0 , of Li in the diluent. Make sure that calibration and measurement samples contain the same concentration of Li.

Cont

'Cont.' is short for continuous. Readings are continually updated. There are no time-outs or delays. This mode can be used in various combinations with Single, Dual and Ref.

There is one major difference from the Peak mode, a press of 'Print' causes the output of the current displayed reading to whatever is connected to the RS232 connector, e.g. printer, computer, data logger.

5.3.4 Blank

Blanking can be initiated at any time during a measurement session by pressing 'Blank', having already introduced a blank sample. There are 5 circumstances where it is initiated automatically by the instrument as part of the start-up sequence: -

- On initial Switch on after Diagnostic sequence
- immediately after use of 'Peak./Cont'
- immediately after use of 'Single/Dual'
- immediately after any element selection process
- immediately after 'Set' is pressed during a measurement session

NB It may be that more than one of the above buttons is pressed as the user selects a new operating mode. "000" flashing in the measurement displays will indicate that the instrument is waiting for the user to press 'Blank' and the blanking process will not commence until it is pressed.

6

Operating the Instrument

6.1 Start Up

After completing the assembly of the instrument as described in Chapter 2 (remembering to fill the 'U' tube with water and to allow the waste water to fall to a reservoir) the instrument is ready to be started.

6.1.1 Compressor Start Up

Switch on the compressor and adjust the air regulator assembly (see Section 5.2) to read 11psi on the gauge.

6.1.2 Switch On

The Model 420 and Model 425 automatically select a high gas /air ratio to ignite the flame. If the instrument has been switched off recently then the flame should ignite at the first operation of the 1/0 switch. If not then two or even three operations might be necessary to fill the gas tube up-stream of the instrument.

6.1.3 Ignition Successful

The instrument automatically selects a reduced gas/air mixture, which optimises the flame for highest sensitivity.

The Flame detector operates and the "flame on" light illuminates.

6.2.1 Required Blanking

When the instrument has just been switched on it automatically goes into blanking mode as soon as the flame has lit (although this may be temporarily interrupted by the date and time setting and other processes described in Section 2.7 to 2.9).

At this point: "Measure" and "Cal" are off, the display(s) flash "000" and the instrument waits for the user to introduce the blank sample before pressing 'Blank'.

'Blank' affects all channels simultaneously, even Li whether being used for reference or not. The instrument brings the readings of all channels to zero, a steady display of "0.0" on all enabled channels.

Operating the Instrument

continued

6.2.2 Required Calibration

(NB Li must be in diluent if operating in Ref).

On initial start up the instrument requires a Calibration step after the Blanking process. The instrument goes into calibrate mode with the "Cal"(s) flashing, "Measure" off, and the most recent calibration values on the display.

The 'Single' and 'Dual' mode of operations both Calibrate in the same manner.

The preparation and presentation of standards in "Dual" are different for "Cont" and "Peak".

<p>Continuous Mode.</p> <p>(In Dual Mode standards can be presented as individual elements and each channel separately calibrated). The channel(s) should be adjusted to desired value(s) using '-' or '+'. When desired value(s) are flashing <u>introduce the standard and then</u> press 'Set' in any order within 2 seconds of each other. The user waits for readings to reach <u>what the user judges to be steady plateau values</u> and presses 'Set' on each channel at the appropriate time to confirm the values. As these presses of 'Set' are registered the displayed readings are adjusted to calibration values, the output is sent and the instrument goes into measure mode with "Measure" on and "Cal" off.</p>	<p>Peak Mode (With Reference is Default Mode). (In Dual Mode both Sodium and Potassium standards must be mixed and presented as one solution as there is no operator involvement in the calibration sequence). Each channel should be adjusted to desired value using '-' or '+'. When desired value is achieved press "Set" on that channel and then modify the other channel if necessary and <u>introduce the calibration sample IMMEDIATELY BEFORE pressing 'Set' on the second channel.</u> The "Peak" process starts on both channels and readings are displayed. Once the Peak algorithm has accepted the values, and the displays on both channels change to the calibrated values, the user presses 'Set' on both channels and the output is sent. The displays start flashing, "Cal" goes out, "Measure" comes on and the instrument is ready to measure.</p>
---	--

Operating the Instrument

continued

6.3 Sample Measuring

6.3.1 Measuring in Peak mode

The cycle commences with the introduction of a new sample, quickly followed by pressing 'Measure'. The instrument starts the built-in delay (which can be varied see Section 2.9) as soon as a press of 'Measure' has been registered (whether a short, long or double press does not matter).

Readings are displayed on all operative channels and 'measure' is flashing.

Once the peak mode algorithm is satisfied, the values will "freeze", the signals are corrected to the reference signal, "measure" will become steady and a valid measurement value will be output to the RS232 serial port.

After 5 seconds the Display(s) will flash prompting the user to remove the sample, introduce a new sample and press 'Measure' to start the cycle again.

6.3.2 Measuring in Continuous mode

In Continuous Mode, after introducing the sample, the user will decide when the displayed results have stabilised and the reading can be taken and/or sent to the printer/output. When he/she is so satisfied then a simple press of the 'Measure/Print' button will send the currently displayed/measured value to the output port. A new sample can be presented at any time and the user again can take the result when it is judged ready.

6.4 Automatic operation

Both the Model 420 and Model 425 can be easily used in a partial or fully automatic system using the Sherwood Model 805 Continuous Flow Diluter and the Sherwood Model 860 Autosampler.

The Model 805 diluter is specifically designed to work with either system for Clinical samples, especially when used in "Ref" Mode where the Lithium Internal standard is diluted using the Model 805, will give excellent drift free reproducibility.

The Model 860 Autosampler is used as a slave to the Flame Photometers and operates the Blank and Calibration and Measure cycle under the commands already described in Sections 6.2 and 6.3 above.

Full details of these products are available at the Sherwood Scientific website www.sherwood-scientific.com

Operating the Instrument

continued

6.5 Sample Numbering

The Sample number is set at 001 when the initial calibration is successful and the “measure” light is illuminated. The sample number is then incremented at each single press of the ‘Measure’ button both in “Cont” and “Peak” modes.

6.5.1 Reset of sample number

The sample number is reset to 001 when a calibration is carried out or if both “+” s are pressed simultaneously.

6.5.2 Repeat sample

If it is necessary to repeat a sample so that the new value is listed against the same sample number then the “Measure’ button is pushed twice; the output is RRR instead of the next sample number.

6.5.3 QC sample

A Quality Control sample can be identified by a long push on the print button: the output is then QQQ and the next sample is not incremented.

To confirm that the instrument has accepted these different pushes on the “Measure” button the measurement display will disappear for two seconds during which time the second push will be accepted.

6.6 Shutdown Procedure

- 1 Aspirate Cleaning Solution diluted 1 in 100 with distilled water, for one minute.
2. Aspirate diluent for two minutes.
3. For a short-term shutdown (two hours) switch off the instrument at the power switch and switch off the compressor.
4. For a longer term shutdown (overnight) turn off the fuel supply at source. When the flame on LED is extinguished, switch off the power switch, and the compressor. This ensures that the fuel pressure in the fuel tubing is at a minimum.

NB *Remember that the Instrument will remain HOT for a considerable time after switch off.*

7 Operating Hints, Precautions & Limitations

7.1 Hints

1. The high quality distilled water used when making a batch of diluent must be free from contaminating elements. It is recommended that the same batch of diluent be used to prepare all solutions and to set 'blank' on the instrument.
2. Greatest accuracy will be obtained by using the same dilution equipment for both standard and sample preparation.
3. Always use suitable standards for calibrating the instrument. Remember that the accuracy of the results obtained from the any Flame Photometer depends on the accuracy and purity of the calibration standard that is used.
4. A 'Guide to Flame Photometry' containing Applications and Method Sheets is available from your Sherwood Scientific Distributor.

7.2 Operational Precautions and Limitations

1. Always dilute samples and standards with the same batch of diluent (made up of 1 part Diluent Concentrate and 999 parts of good quality distilled water), which contains non-ionic wetting agents.
2. The samples should not be highly viscous or non-homogeneous. If possible, samples likely to contain sediment should be filtered and then mixed to obtain a representative result.
3. Always use soap solution when checking for leaks in fuel or air lines. Do not allow fuel to flow in the presence of unguarded flames, e.g. cigarettes.
4. Always use genuine Sherwood Scientific replacement parts. Do not, for example, replace the 'U' tube with one of different material, bore or length as this will cause a deterioration in the instrument's performance.
5. Always carry out the maintenance schedules as detailed in Section 8.
6. Do not leave the inspection flap open, unless adjusting flame conditions, as this will allow stray light to enter the chimney.
7. The front panel of the M420/425 is impervious to a wide range of chemicals. However, strong acids and some organic solvents e.g. Chloroform and Phenol may affect the finish. Any spillage should be thoroughly wiped away as soon as possible. If necessary, clean the instrument with warm, soapy water - do not use abrasives.

Operating Hints, Precautions and Limitations

continued

7.3 Hazards

1. All electrical instruments are potentially hazardous. With the exception of the glass chimney, there are no user-maintainable parts inside the Model 420/425 covers. Never remove covers from the instrument, unless specific maintenance instructions are being followed.
2. Propane and Butane are highly inflammable and potentially explosive gases. Propane and Butane are stored as a liquid, under pressure in a cylinder, for use with the instrument. Such a cylinder should never be subjected to heat or mechanical shock. When handled correctly and connected to the instrument as instructed, the fuel gas is quite safe. Check hosing joints with a soap solution before allowing any naked flame in the vicinity. Never open a cylinder valve to the atmosphere even on a supposedly empty cylinder.
3. **The chimney cap and glass chimney and the area above the chimney can become very hot and are capable of causing severe burns. Never view the flame from the top of the chimney, always use the inspection hole.**
4. Make sure that the air compressor is connected to the power supply and switched on before starting a flame ignition sequence. If this is not done the instrument will not light, as there is a safety cut out which detects the air pressure. If there is no air pressure, error code 'E61' will be displayed 'No Flame'.

7.4 Measuring Calcium

The Model 425 has the additional channel for Calcium, which has been requested by many customers.

It should be noted however that because the Model 425 uses propane /air flame there is not sufficient energy to break the calcium phosphate bond which may occur within, particularly, clinical samples. In these samples, a pre-treatment protocol must be used. Sherwood has a method on our website:

www.sherwood-scientific.com/apps/f003m.html

With other calcium samples, chelation with EDTA or extraction with Mehling's 3 solution may be indicated.

8 Cleaning and Maintenance Procedures

8.1 General

Under the Daily, Weekly, Monthly and Six-Monthly Maintenance headings are summaries of the work and equipment required. The tasks are detailed from Section 8.6 onwards.

For maintenance of the Air Compressor and Dilutor, if used, refer to the instructions supplied with the equipment.

8.2 Daily Maintenance

EQUIPMENT REQUIRED: -

None.

1. Empty waste container, if used.
2. Check air line for condensation, and drain if necessary.
3. Check 'U' tube is filled with water.

8.3 Weekly Maintenance

EQUIPMENT REQUIRED: -

10ml beaker

Stopwatch

Nebuliser cleaning wire

Deproteinising Solution

Stainless steel nebuliser tube and sleeve, or polythene inlet tube, as required.

1. Carry out Daily Maintenance procedure.
2. Deproteinise the system (see Section 8.10).
3. Check the operation of the nebuliser (see Section 8.6).

8.4 Monthly Maintenance

EQUIPMENT REQUIRED: -

As for weekly maintenance.

1. Carry out Daily and Weekly Maintenance procedures.
2. Check the constant head and drain, mixing chamber, 'U' tube and drain tube and clean if necessary (see Section 8.7). Check that the 'U' tube is refilled with water on re-assembly.

Cleaning and Maintenance Procedures

continued

8.5 Six Monthly Maintenance

EQUIPMENT REQUIRED: -

As for weekly maintenance, plus the following: -

'U' tube and drain tube

Methanol

Tissues

Soft lint-free cloth

Cotton buds

1. Carry out the Daily and Weekly Maintenance procedures.
2. Clean the mixing chamber, burner tube, burner and constant head and drain (see Section 8.7).
3. Replace polythene nebuliser tube, 'U' tube and drain tube.
4. Clean the optical filters and the glass chimney (see Section 8.8).
5. Check the air and fuel tubing and connectors for leaks, using soap solution.

8.6 Nebuliser

EQUIPMENT REQUIRED: -

Stopwatch

10ml beaker

Cleaning wire

Cleaning Solution

Polythene inlet tube

8.6.1 Operational Check

1. Turn off the fuel supply at source.
2. Switch on the instrument and the air compressor. Check that the 'flame on' LED is off.
3. Fill the beaker with deionised water, and weigh it.
4. Present the 10ml beaker of deionised water to the nebuliser tube for an accurately timed minute.
5. Re-weigh the beaker and calculate the aspiration rate. If it is between 3 and 6g per minute, no further action is required.
If it is too low, continue with paragraph 6. If it is too high contact your Sherwood Scientific Distributor.

Do not attempt to adjust the nebuliser as the capillary position is fixed during manufacture, and is not adjustable.

Cleaning and Maintenance Procedures

continued

8.6 Nebuliser, continued

8.6.2 Cleaning the Nebuliser

6. Release the Nebuliser Retainer (item 2, figure 2.1) and withdraw the Nebuliser (item 1, figure 2.1).
7. Remove the Nebuliser Inlet Tube. Insert a Cleaning Wire into the capillary tube at the rear of the Nebuliser and pull right through.
8. Insert the Cleaning Wire into the Nebuliser Inlet Tube and pull right through. Inspect the Nebuliser Inlet Tube; replace if signs of wear or accumulation of particles are apparent.
9. With the Nebuliser Inlet Tube removed, but with the Nebuliser attached to the Air Tubing, place a finger over the Nebuliser Outlet Nozzle, turn on the air supply to force any residue out of the Nebuliser's capillary tube.
10. Refit the nebuliser inlet tubing to the nebuliser. Recheck the aspiration rate, paragraphs 3, 4, and 5.
11. If nebuliser operation is still outside the specification, unscrew the air line connector and remove the nebuliser inlet tubing.
11. Soak the nebuliser in a 1 in 100 dilution of Cleaning Solution, agitating it periodically.
12. Rinse thoroughly in deionised water and shake dry.
13. Refit the nebuliser inlet tubing and the air line. Re-check aspiration rate.
14. If the nebuliser operation is still unsatisfactory, fit a new nebuliser.

Cleaning and Maintenance Procedures

continued

8.7 Cleaning the Mixing Chamber, Burner and Drain

EQUIPMENT REQUIRED: -

Flat blade screwdriver, blade width 8 mm

Deproteinising Solution

Tissues

1. Check that the flame on LED is off, fuel is turned off at the source, and the instrument and compressor are switched off.
2. Turn the nebuliser retainer and withdraw the Nebuliser (item 1 and 2, figure 2.1).
3. Disconnect the Fuel Tubing (item 5, figure 2.1) from the end cap connector (item 6, figure 2.1) using a twisting movement. Do not pull the tubing, as this will make it grip the connector more tightly.
WARNING Use a heat resistant glove when handling the chimney, burner and burner tube if the flame has been alight within the preceding 30 minutes.
4. Remove the Chimney Cover and lift out the Glass Chimney.
5. Disconnect the Mixing Chamber from the chimney assembly by twisting it to the right, through 40 degrees. Lower the mixing chamber and burner assembly.
6. Lift the burner tube from the mixing chamber and remove the burner.
7. Unscrew the end cap securing screw (item 7, figure 2.1). Grasp the end cap (item 6, figure 2.1) and remove it from the mixing chamber, with a slight twisting action. Lift the end cap to allow the water in the 'U' tube to flow into the constant head and drain. Disconnect the 'U' tube from the end cap and constant head and drain.
8. Unclip the constant head and drain and disconnect the drain tube.
9. Soak all the items removed from the instrument in a 1 in 100 dilution of Cleaning Solution, agitating it periodically.
10. Rinse the parts thoroughly in distilled water and dry with clean tissues.
11. Fit the burner tube to the mixing chamber, ensuring that the locating slot in the burner tube engages with the locating pin in the mixing chamber.
12. Fit the burner pointed end downwards into the burner tube. Rotate the burner to ensure that it is fully inserted.
13. Check the condition of the end cap 'O' ring seal. If necessary, replace the seal.
14. Replace the end cap, using a twisting movement. Align the hole with the mixing chamber screw fixing. Fit the screw (item 7, figure 2.1).
15. Carefully position the mixing chamber, with the burner tube inside the chimney. With the burner tube fully inserted, twist the mixing chamber to the left, through 40 degrees, to lock it in position.
16. Fit the constant head and drain so that it is pushed fully down on its locating screws.
17. Connect the fuel tubing to the mixing chamber end cap. Connect the 'U' tube between the mixing chamber end cap and the constant head and drain. Fit the drain tube to the constant head and drain.
18. Fit the nebuliser into the end cap and position the retainer to lock it.
19. Use a wash bottle to completely fill the 'U' tube with water.

Cleaning and Maintenance Procedures

Continued

8.8 Cleaning the Filters and Glass Chimney

EQUIPMENT REQUIRED: -

Soft lint-free cloth

Methanol

Cotton buds

Tissues

Cleaning Solution

1. Check that the 'flame on' LED is off, fuel is turned off at the source, and the instrument and compressor are switched off.

WARNING Do not proceed until all the parts within the chimney are at a safe handling temperature.

2. Lift off the chimney cap and lift out the glass chimney.
3. Soak the glass chimney in a 1 in 100 dilution of Cleaning Solution, agitating it periodically.
4. Rinse the glass chimney thoroughly in deionised water and dry with clean tissues.

For Filters.

5. Remove the two screws at the rear of the chimney underneath the flange and the two thumbscrews under the front of the chimney.
6. Lift the chimney assembly up slightly before leaning the top forwards. Balance the bottom on the chimney tray.
7. Remove the two screws holding the filter & detector housing together and to the mounting bracket located on the plinth. Then gently ease the two halves apart and remove the filter from its slot.

CAUTION: Handle the optical filters only by the edges, never the faces.

8. Carefully wipe the filter with a cotton bud soaked in methanol.
9. Re-fit the filters mirror side facing the flame and plastic spacer nearest the flame and re-assemble the housing. For Ca in the M425 a Didymium filter is placed in front of the filter instead of a spacer, this too will need cleaning.
10. Replace the glass chimney with the clear strip at the bottom. Make sure the glass chimney is seated correctly and re-fit the chimney cap.

Cleaning and Maintenance Procedures

Continued

8.9 Deproteinising or Disinfecting Procedure

NOTE To deproteinise the system use Enzymatic Cleaner/Disinfectant Solution, to disinfect the system use Tubing Disinfectant.

EQUIPMENT REQUIRED: -

Enzymatic Cleaner/Disinfecting Solution or Tubing Disinfectant.

1. Dissolve one 5g sachet in 1 litre of warm (~ 35°) tap water.
2. Light the flame as detailed in Section 5.4.
3. Present a beaker of Enzymatic Solution or Tubing Disinfectant to the nebuliser for 5 minutes.
4. After 5 minutes have elapsed; replace the beaker of the solution with a beaker of deionised water. Aspirate for two minutes. Then with a fresh beaker of deionized water aspirate for a further 10 minutes
5. Shutdown the instrument as detailed in Section 6.6.

For disassembled components e.g. mixing chamber, burner, burner stem, nebuliser – soak, completely immersed in the warm solution. Afterwards rinse thoroughly, first in one batch of deionized water, followed by a second batch.

9 Accessories, Consumables & Spare Parts

9.1 Ordering Information

When ordering spares or accessories for your instrument, please give the following information to your Sherwood Scientific distributor.

Instrument Serial Number
 Catalogue Number of Part (Cat. No.)
 Description
 Quantity required

This will ensure that your order is dealt with quickly and efficiently.

The number shown in the third column (Quantity) is the quantity of items that are supplied against the stated Catalogue Number. If the quantity is greater than 1, then only multiples of that quantity can be supplied.

9.2 Spares and Accessories

Spares

Catalogue#	Description	Quantity
420 08 102	Nebuliser	1
410 26 001	Mixing chamber and burner	1
402 12 001	End Cap Assembly	1
400 02 013	End cap securing screw	1
401 11 001	Constant Head & Drain (moulded) Large	1
400 22 003	Nebuliser inlet tube, polythene, 150mm each	1
400 22 012	Nebuliser inlet tube, polythene, 150mm Pk 12	1
420 08 022	Fuel restrictor 22 g	1
420 08 023	Fuel restrictor 23 g	1
001 26 033	Sample pot, plastic, in packs of 50	1 pack
420 27 137	Sodium filter, Factored	1
420 27 138	Potassium filter, Factored	1
420 27 139	Lithium filter, Factored	1
420 27 140	Calcium filter, Factored	1
001 27 088	Didymium filter	1
001 08 234	Propane primary regulator	1
001 08 439	Butane primary regulator for 7kg Calor/Caravan cylinder	1
001 72 114	Fuel tubing, reinforced	per metre
001 72 025	Gas tubing (internal)	per meter
400 22 002	Tube Drain - all flames up to #20585 & after #28016	1 metre
400 72 002	Tube 'U' for 410/420/425 upto #20585 & after 28016	1
001 08 718	'Unex' tubing clamp	1
100 99 010	Nebuliser cleaning wire, pack of 3	1 pack
926 09 052	RS232 Output Cable	1

Accessories Components and Spare Parts

continued

Accessories

420 66 000	BlueNotes 420 Software	1
473 86 009	Printer assembly, universal	1
475 41 100	M805 Continuous Flow Diluter for Clinical Samples 1:200 Ratio	1
860 00 009	Model 860 Autosampler 40 position	1
851 01 001	Model 851 Air Compressor	1
855 01 001	Model 855 Air Compressor, complete with water separator	1

9.3 Reagents

Catalogue #	Description	Quantity
001 56 100	140.0mmol/Na, 5.00mmol K, 1.50mmol/L Li, 100ml	1 Bottle

NOTE: The following solutions are also available

001 56 620	Flame Photometer Standard, 1000ppm Na, 6 x 100ml	1 Pack
001 56 621	Flame Photometer Standard, 1000ppm K, 6 x 100ml	1 Pack
001 56 622	Flame Photometer Standard, 1000ppm Li, 6 x 100ml	1 Pack
001 56 623	Flame Photometer Standard, 1000ppm Ca, 6 x 100ml	1 Pack
001 56 603	Flame Photometer Standard, 3Molar Li, 100ml	1 Bottle
001 56 681	Diluent Concentrate, 6 x 100ml	1 Pack
001 56 682	Tubing Disinfectant, 6 x 100ml	1 Pack
001 56 183	Deproteinising Solution, 6 x 80ml	1 Pack

Appendix A

Bibliography

Reference

1. Kolthoff, I.M., *Z. Anal. Chem.* 70 397 1927
2. Shohl, A.T., and Bennett, H.B. *J. Biol. Chem.* 78: 643 1928
3. Hald, P.M., *J. Biol. Chem.* 167. 499. 1947
4. Bernstein, R.E., *S.Afr. J. Med. Sci.* 17. 101, 1952
5. Alkemade, C.T.J., Smit J. and Verschure J.C.M. *Biochimica et Biophysica Acta.* 8. 562. 1952
6. Collins G.C. and Polkinthorne H., *The Analyst*, 77, 917 pp. 430-436, 1952
7. Dryer, R.L., *Clin. Chem.* 2. 112. 1956
8. Puffeles, M. and Nessim, N.E., *The Analyst.* 82. 976, 1957
9. Boling, E.A., *J. Lab and Clin. Med.* 63, 501 1964
10. Amdisen, A., *Scand J. Clin. and Lab. Invest.* 20 (2) 104. 1967

Appendix B

Error	Message	Possible causes	Things to try	Way out for user
E02	Blanking timed out.	Sample ran out. Noisy signal due to sample. Noisy signal due to instrument malfunction.	Check there is plenty of sample. Verify nebuliser uptake rate.	E02 is displayed for 5s, then automatically returns to start of blanking. No output sent.
E05	Blank signal outside offset range.	Blank contaminated.	Check with fresh blank.	Re-start Blank.
E 06	Detector circuit saturated in Blank.	Gross contamination of blank; Blank not being used.	Check with fresh blank.	Re-start Blank.
E09	Blank out of limits. (E09 is displayed on the offending channel(s) and the appropriate element symbol(s) will flash).	There are arbitrary ceilings for blank signals on each element. Sample was not a blank. Signal was too noisy. Li in blank when it shouldn't have been.	Try a guaranteed blank. Check the nebuliser.	E09 is displayed for 5s, then automatically returns to start of blanking. Make sure a blank sample is being aspirated and press "Blank". Output will also indicate error by showing "----" for measurement value(s).
E12	Peak cycle timed out during calibration.	Sample ran out. Noisy signal due to sample. Noisy signal due to instrument malfunction.	Check there is plenty of sample. Verify nebuliser uptake rate.	E12 is displayed for 5s, then automatically returns to start of calibrate (does not go back to beginning of blanking). No output sent.
E15	Calibration Invalid.	Reading/Calibration Factor >99.	Check concentration of Standard has it been diluted correctly.	Start Calibration sequence again.
E16	Detector circuit saturated in Calibrate.	Gross error in Standard concentration; Standard not diluted.	Check concentration of Standard has it been diluted correctly.	Start Calibration sequence again.
E19	Standard reading over-range. (In calibrate only).	There are arbitrary ceilings for signals on each element. Wrong value Standard. Signal was too noisy. Li in Standard when it shouldn't have been.	Check concentration of standard. Increase sample dilution.	In CONT. E19 is displayed until something causes reading to come back in range. In PEAK E19 is displayed until cancelled by introduction of new standard and press of 'Set'.
E22	Peak timed out during measure.	Sample ran out. Noisy signal due to sample. Noisy signal due to instrument malfunction.	Check there is plenty of sample. Verify nebuliser uptake rate.	Press 'Print' in usual way. (To repeat without changing sample number press and hold 'Print') Output will also indicate error by showing "----" for measurement value(s).
E25	Sample > 125% of top standard.	Sample not diluted correctly. Very abnormal sample; incorrect standard used for sample.	Check correct standard; check dilution, if necessary increase dilution ratio.	In CONT. message will disappear when sample removed; in PEAK introduce new sample and press Print.

Error	Message	Possible causes	Things to try	Way out for user
E26	Detector circuit saturated in Measure mode.	Sample not diluted correctly.	Check dilution of sample.	Re introduce correctly diluted sample.
E29	Sample reading over-range. (In measure only) (Output shows ***.* for value).	Maximum reading that display can produce is "199.9".	Check concentration of sample. Increase sample dilution.	In CONT. E29 is displayed until something causes reading to fall below "199.9". In PEAK E29 is displayed until cancelled by introduction of new sample and press of 'Print'.
E30	Li signal outside limits in blanking. (In Ref. mode only). (E30 displayed on Ch2 and "Ref." flashes).	Li Concentration in the final Blank solution should be 100ppm.	Check source of Li. Check dilutor and tubing. Check nebuliser.	E30 is displayed for 5s, then automatically returns to start of blanking. No output sent.
E35	Li out of range in measure + Ref. mode. (E35 displayed on active channels and "Ref." flashes).	Limits on the excursions of the Li signal in ref. mode are $\pm 20\%$ about the value at calibration. Either Li has run out or there is a fault with the instrument or dilutor.	Check source of Li. Check dilutor and tubing. Check nebuliser.	E35 is displayed on active channels and "Ref." flashes for 5s, then automatically returns to start of blanking. Aspirate a blank solution and press 'Blank'.
E39	Li signal outside limits in calibrate. (In Ref. mode only). (E39 is displayed on Ch2 and "Ref." flashes).	Li Concentration in the final Standard solution should be 100ppm.	Check concentration of sample. Increase sample dilution.	E39 is displayed for 5s, then automatically returns to start of calibrate (does not go back to beginning of blanking). Ensure diluent has correct Li concentration.
E61	Flame had not ignited by the end of the ignite cycle.	No gas from supply; gas leak; no water in constant head tube; air pressure low or zero (compressor problem, wrong setting of regulator or leak).	Check that there is gas and that it is connected; check that the constant head tube is full; check there is air, that it is connected and that the pressure showing on the gauge is correct.	Switch off, wait a moment then switch on again.
E62	Battery Back up Failure on Power On.	Circuit Fault or Battery fault.	Can reset Filter Factors. See Manual.	Press "Blank" to continue. Have to reset Standard Values each time user calibrates.
E68	Serial Interface not responding.	Serial device not switched on or faulty.	Switch on device or replace.	Remove faulty device, which will remove error code.
E69	Microprocessor not responding.	Temporary electronic transient.	Switch Off and On again after 15 second delay.	

Appendix C

Using the Zero offset and Span control in “301” Mode for Model 425

This mode was introduced to improve the flexibility of interfacing the Model 425 with other analytical equipment. It allows the normal calibration routine to be bypassed and is more suitable for continuous flow analysers.

Setup

- 1 Reset the Model 425 by pressing and holding down the “Blank” control until the display shows “300”, (following the sequence 2.8-2.10 in the Operator Manual).
- 2 Change the setting to “301”. Press ‘Set’.
- 3 “401” is displayed this allows the damping to be changed see (section 2.11 in Operator manual). Press ‘Set’.
- 4 Display reverts to the blank setting “000” flashing on each channel.

Operation of Zero Offset

- 1 Aspirate blank solution and press “Blank”.
- 2 When blank is “captured” after 5 seconds the “Cal” lights flash.
- 3 Operate the “+” or “-” keys to change the output analogue voltage.
- 4 Press “Set”.

Operation of the Span

- 1 “Std” will be displayed. Aspirate the appropriate standard (e.g. 10.0ppm Na. This should be greater than the maximum concentration expected from samples to ensure that the samples appear on scale at the analogue output.)
- 2 Whilst aspirating the standard change the “+” or “-” controls to change the span setting on the analogue voltage. Press “Set”.

Measure

Having set the Zero offset and span, all samples should now fall within these two analogue voltages.

Sherwood Scientific Limited Product Warranty Statement

Warranty Term: 12 Months

Sherwood Scientific Ltd (Sherwood) warrants, subject to the conditions itemised within this document, through either Sherwood personnel or personnel of its authorised distributors, to repair or replace free of all charges, including labour, any part of this product which fails within the warranty time specified above, appertaining to this particular product. Such failure must have occurred because of a defect in material or workmanship and not have occurred as a result of operation of the product other than in accordance with procedures described in the instructions furnished with this product.

Conditions and specific exceptions that apply to the above statement are as follows:

1. End-user warranty time commences on the date of the delivery of product to end-user premises.
2. '*Free of all charges*' statement applies only in areas recognised by Sherwood as being serviced either directly by its own personnel, or indirectly through personnel of an authorised distributor. Products purchased outside these areas requiring service during the warranty period will incur charges relative to the travel/transit costs involved. However, products purchased in such areas will be serviced during the warranty period free of all charges providing they are returned, carriage paid, to either Sherwood or by pre-arrangement to an authorised Sherwood distributor.
3. All maintenance (other than operator maintenance as described in the instructions), repairs or modifications have been made by Sherwood or Sherwood authorised personnel.
4. This product has where applicable been operated using Sherwood specified supplies and reagents.
5. Sherwood reserves the right to make any changes in the design or construction of future products of this type at any time, without incurring any obligation to make any changes whatsoever to this particular product.
6. Reagents, supplies, consumables, accessories and user maintenance items are not included in this warranty.

Product Warranty Statement (continued)

7. Repairs or replacement of any part failing due to abnormal conditions including the following, are excluded from this warranty:
 - a. Flood, lightning, earthquake, tornado, hurricane, or any other natural or man-made disaster.
 - b. Fire, bombing, armed conflict, malicious mischief or sprinkler damage.
 - c. Physical abuse, misuse, sabotage or electrical surge.
 - d. Damage incurred in moving the product to another location.

8. User agrees to permit Sherwood personnel or personnel of its authorised distributor to make changes in the product which do not affect results obtained, but do improve product reliability.

Representations and warranties purporting to be on behalf of Sherwood made by any person, including distributors and representatives of Sherwood, which are inconsistent or in conflict with the terms of this warranty (including but not limited to the limitations of the liability of Sherwood as set forth above), shall not be binding upon Sherwood unless reduced to writing and approved by an officer of Sherwood Scientific Ltd.

Except for the obligations specifically set forth in this warranty statement, in no event shall Sherwood be liable for any direct, indirect, special, incidental, or consequential damages, whether based on contract, tort or any other legal theory and whether advised of the possibility of such damages.

Neither Sherwood nor any of its third party suppliers makes any other warranty of any kind, whether expressed or implied, with respect to Sherwood Products.

Sherwood Scientific Ltd.,
1 The Paddocks,
Cherry Hinton Road,
Cambridge,
CB1 8DH,
England